

PC2-LIMBO
DVI Video

© EKF • draft - do not scale • ekf.com

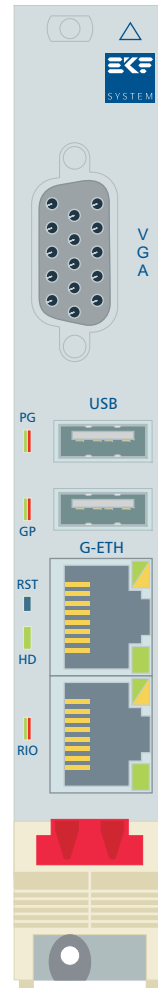

PC2-LIMBO
VGA Video

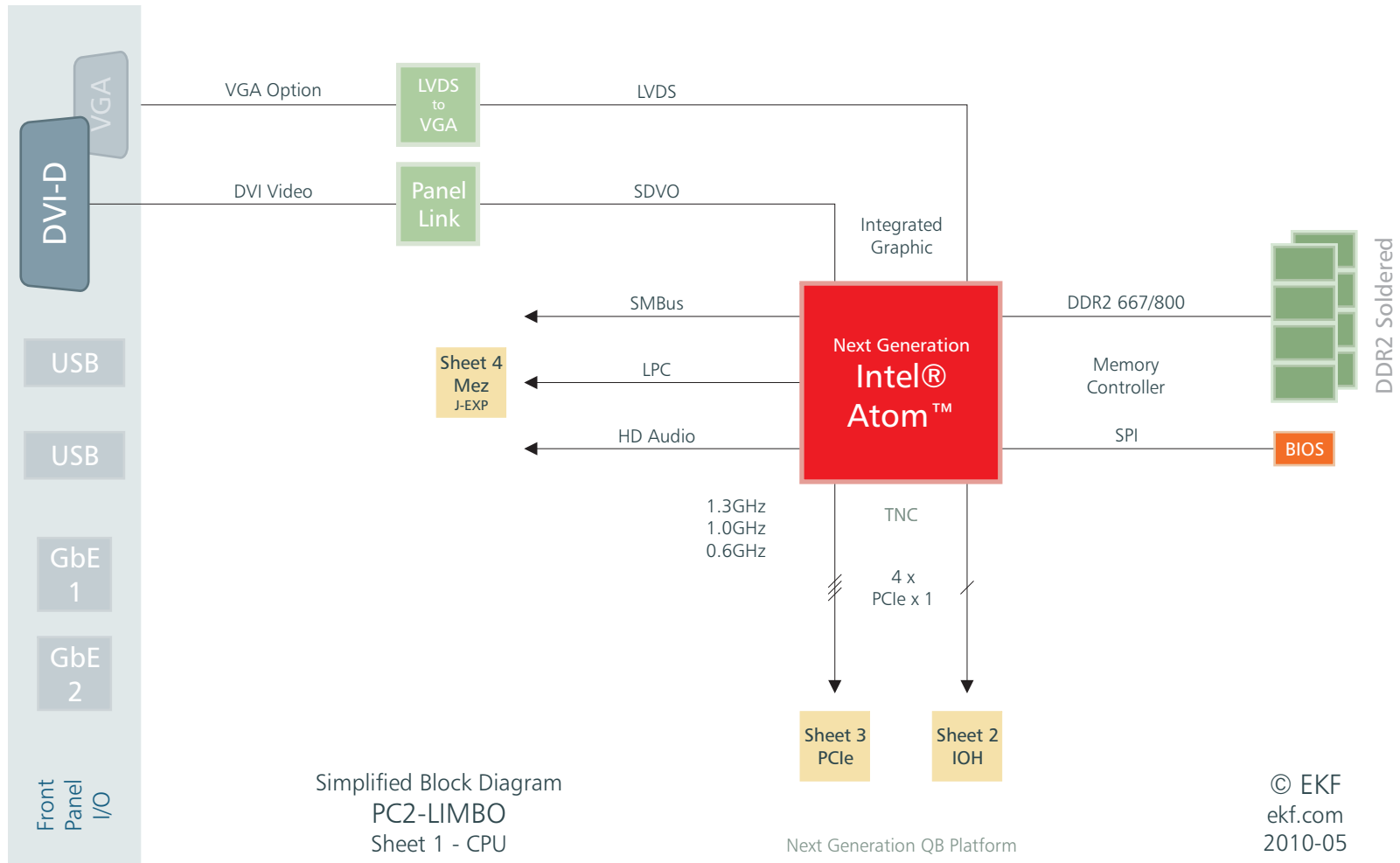

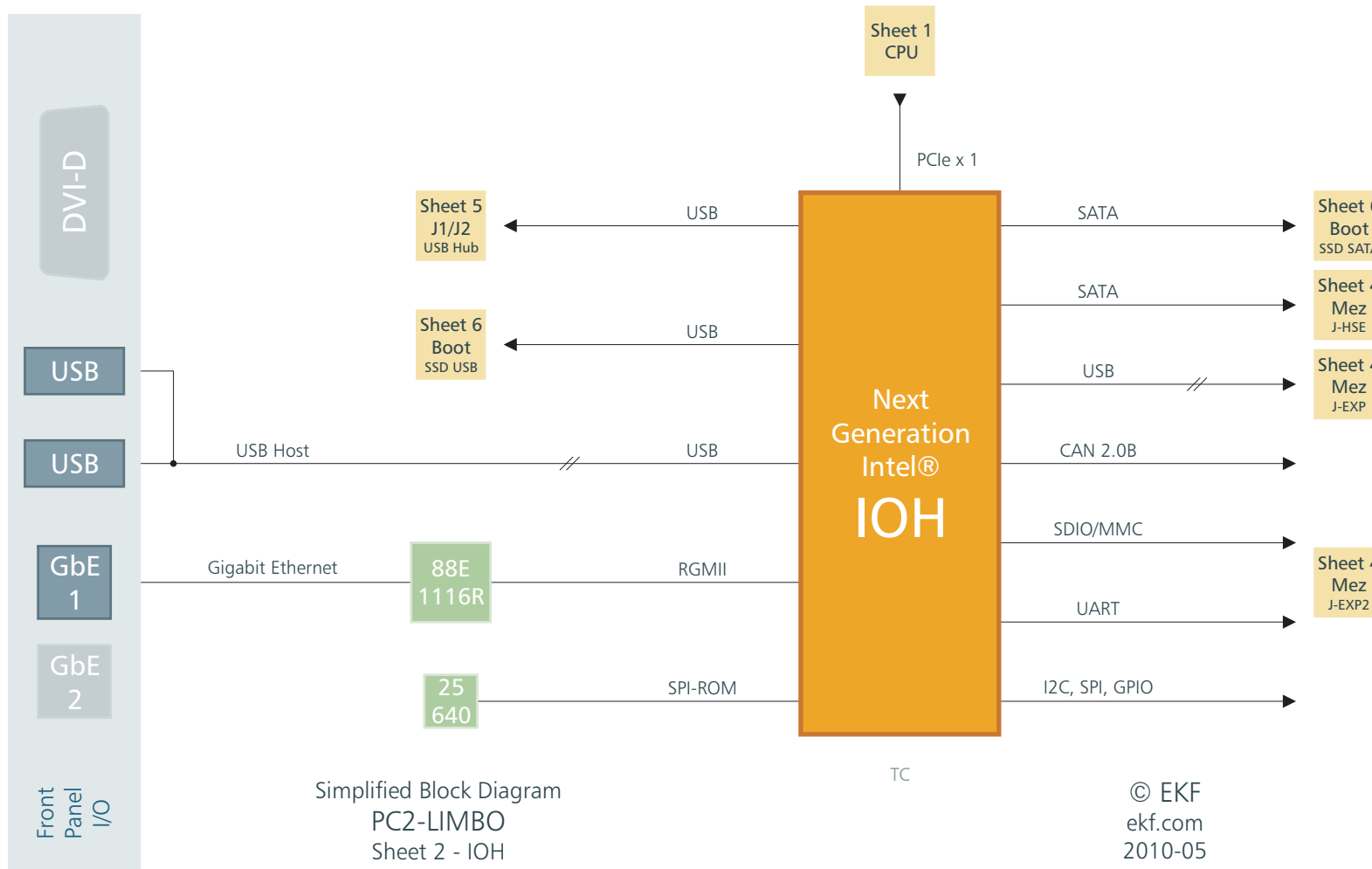

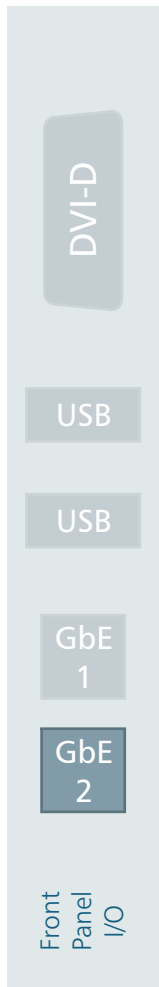

Simplified Block Diagram
PC2-LIMBO
Sheet 3 - PCIe

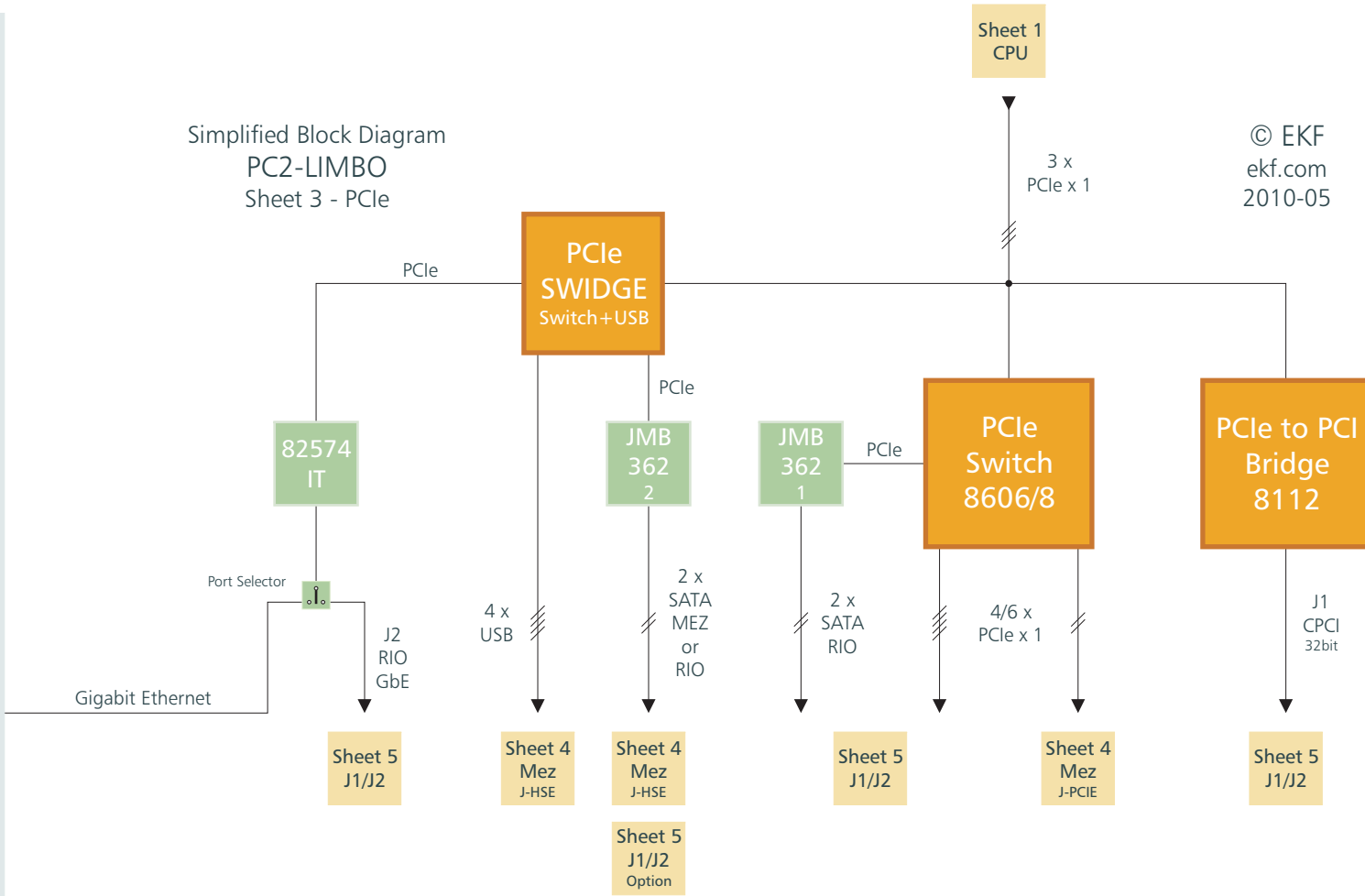

© EKF
ekf.com
2010-05

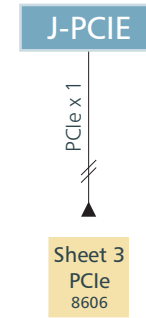
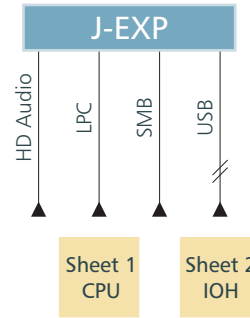
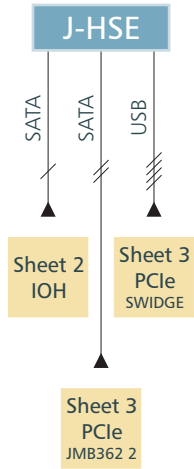

Simplified Block Diagram
PC2-LIMBO
Sheet 4 - Mezzanine I/O

© EKF
ekf.com
2010-05

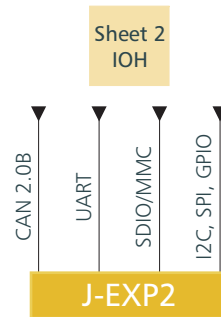

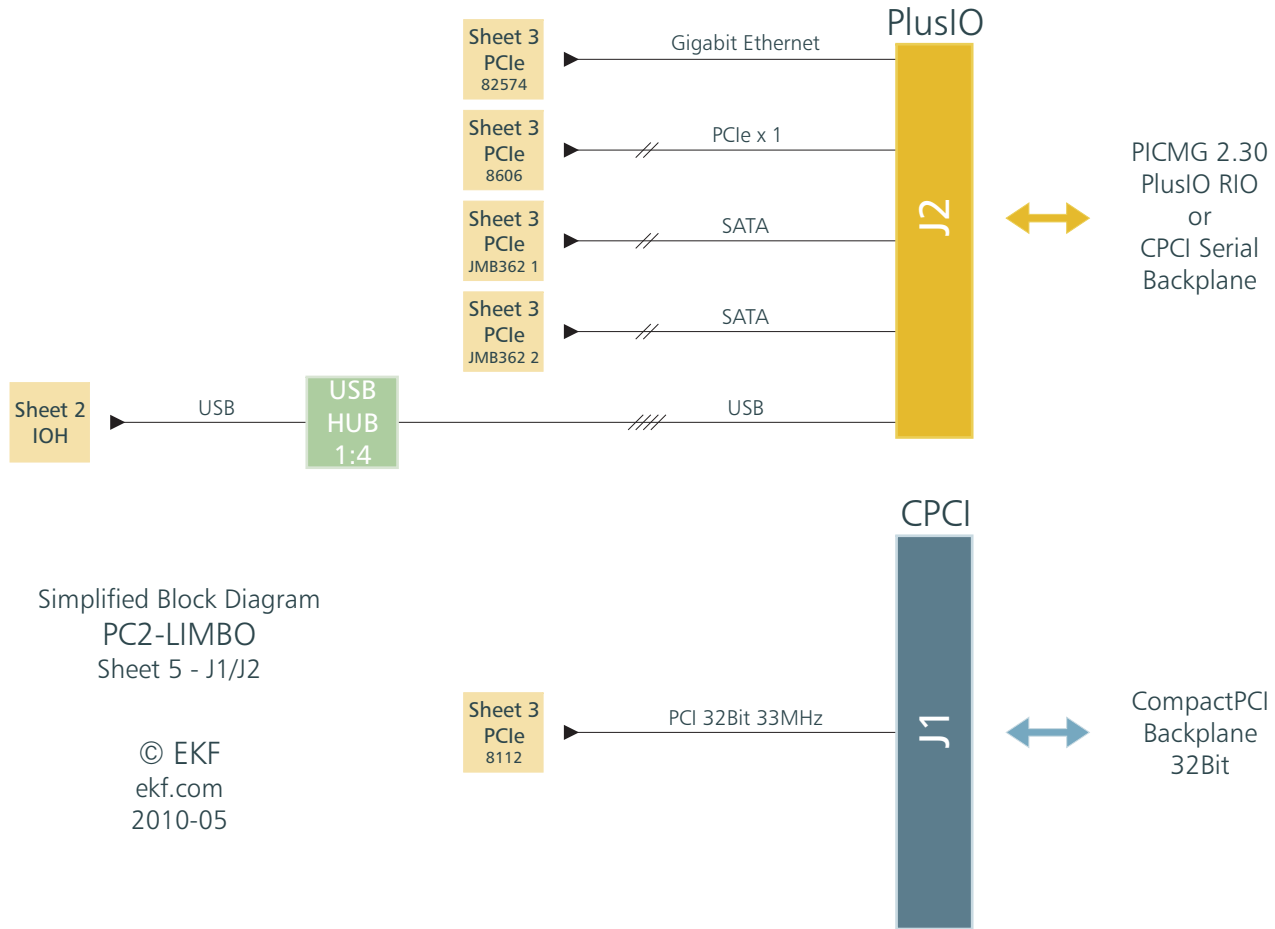

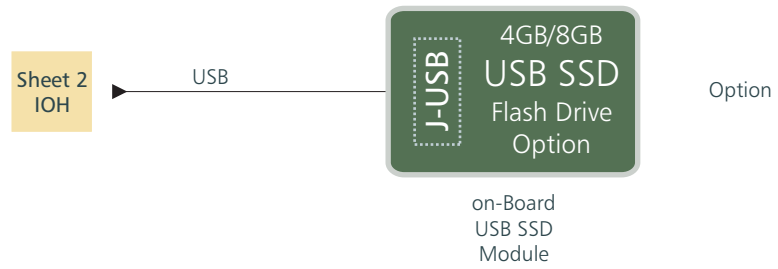
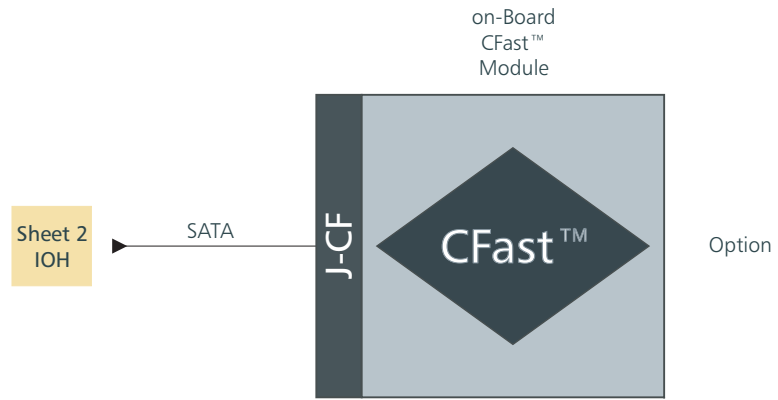

Simplified Block Diagram
PC2-LIMBO
Sheet 6 - Boot SSD